



# The Hinge Guru's Hinge Selection Guide

H. A. Guden Co., Inc.  
99 Raynor Avenue  
Ronkonkoma NY 11779 USA  
1-631-737-2900  
1-800-344-6437 (US)

<http://www.Guden.com>

## Purpose:

This eBook is designed to guide users through the process of selecting a hinge for a new door or lid application. The guide begins by asking whether you need to remove the door or not and then presents the different type of hinges available for the fixed or removable hinge. Each hinge is presented with the features and benefits of the selected type and guides you to a link to all of the customizations available for that type of hinge.

Please work through the process and once you have selected the type of hinge you need for your application, we suggest that you request a sample to test the item in your application. There is a link to our standard products at the end of each section.

With the infinite variety of applications our customers present to us, we cannot recommend a specific product for an application. Only your testing can confirm that the item will perform as you want it to in your application. We will provide no charge samples unless the cost of providing it is prohibitive.

We hope this is of value to you in your search for the right hinge for your application. Feedback is [always welcome](#).

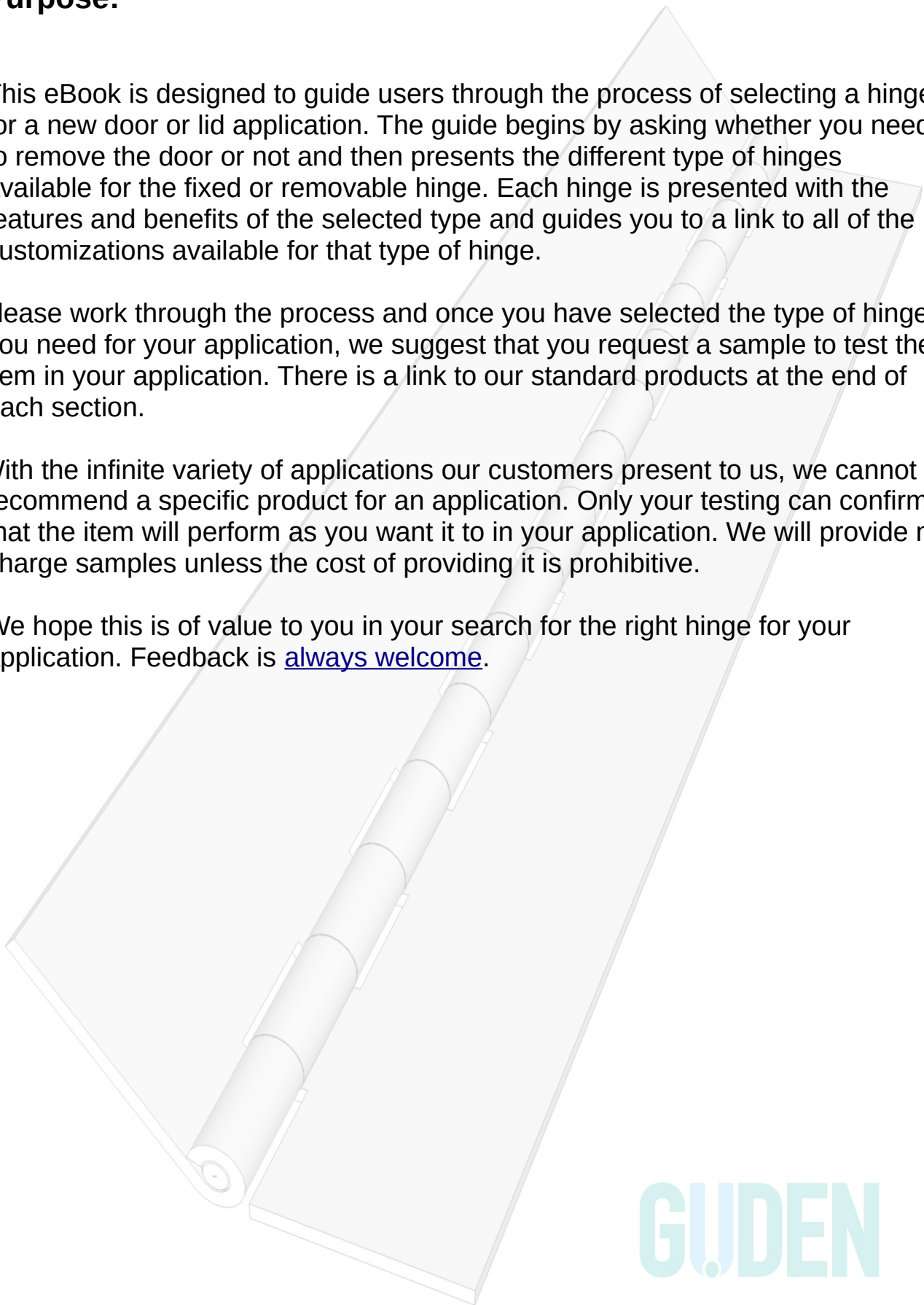

**GUDEN**

# Making the right choices for your hinge







You've already made your first great choice in selecting Guden for your hinge needs. Now to get to the task of deciding which type of hinge to choose for your application. Each particular category of hinge provides unique characteristics and can fill certain application requirements.

We have a video that addresses the general attributes and terminology of hinges that may be helpful before you dig into the actual selection. [YouTube Click here.](#)

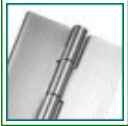
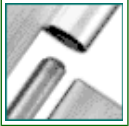
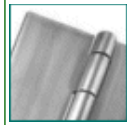
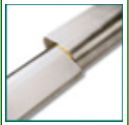
The prototyping phase is key to getting the optimum part for your application. We can help and guide you, but with an infinite number of applications, your own testing is the only way to confirm that you have selected a safe and effective product for your cabinet, box or enclosure. The best way to test is to use samples, and in many cases we are happy to provide samples at no charge. We will also work with you if the part you need isn't readily available from our stock.

The normal place we begin with the selection of a hinge is to ask decide if the door or lid needs to be removable.

## Does your door or lid need to be easily removable?

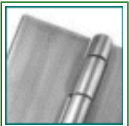
<b><i>FIXED HINGE</i></b>	<b><i>REMOVABLE HINGE</i></b>
Door opens, but remains in place	Door opens and is removable
 <a href="#">Continuous (Piano) Hinges</a>	 <a href="#">Slip Joint Hinges</a>
 <a href="#">Butt Hinges</a>	 <a href="#">Weld-On Hinges</a>
 <a href="#">Spring Hinges</a>	 <a href="#">Latch Hinges</a>
 <a href="#">Plastic Continuous Hinges</a>	 <a href="#">Unhinges</a>
 <a href="#">Concealed and Invisible Hinges</a>	 <a href="#">Butt Hinges with Removable Pins</a>

GUDEN

## Continuous Hinges

- When a longer length is needed along a large door, but also works well in several shorter lengths on the door
- The hinge is supporting weight over a long length
- A lighter gauge hinge may hold more weight due to it's length
- For an overall coverage look or when you want the hinge to completely fill a gap
- More surface for door to hinge connection
- Mounting can be done by welding, or with perforations for fasteners
- [Customization possibilities](#)  are extensive.



## Things to Consider When Choosing a Continuous Hinge

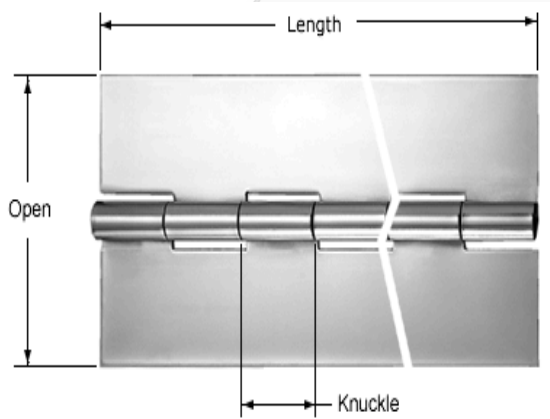

### Sampling and Testing

[Want free continuous hinge engineering samples?](#) Sure! We know the value of prototyping and testing, and we strive to fill reasonable design sample requests quickly.

Building a prototype shouldn't have to be a major expense and an engineering analysis of a prototype is usually the best way to confirm that you have selected a safe and effective product for your application.

Working with the right supplier is the key to the success of your design process and you've already made a great choice with [Guden](#), the hardware experts. With almost 100 years of

experience, the samples, information and advice you can get from us can be priceless in getting your prototype off the ground and onto the production floor.

# GUDEN

## Coverage

Continuous hinges can completely fill or cover the space between your door and chassis. Hiding this gap or juncture can greatly improve the look of your application.

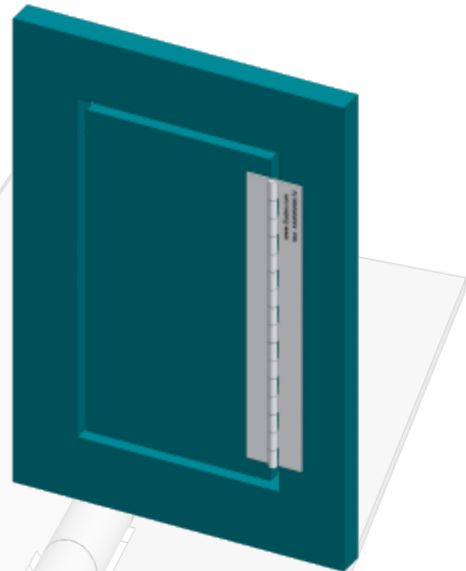

## Leaf Material and Thickness

Plain steel, type 302/304 stainless steel, type 316 stainless steel and types 5052 & 3003 aluminum are the most popular material choices for a continuous hinge. It is also common to have the hinge material match the material of the cabinet or box.

For material thickness, a good starting point is to select the same thickness as the enclosure. If the enclosure has some unusual weight distribution, or high or low door loads you may want to increase or possibly decrease the thickness.

## Pin Size

There are usually only 1 or 2 choices of pin diameter for a given thickness of continuous hinge. As a general rule of thumb, the strongest continuous hinge is one where the pin diameter is about twice the material thickness.

combinations	Leaf Thickness	Popular Knuckle Sizes	Other Knuckle Sizes
	.025	.25	.50
	.032	.50	.25
	.035	.25	
	.040, .050, .060	.50, 1.00, .75	.625, 2.00
	.072, .075	.50, 1.00	2.00
	.090	1.00	2.00
	.120, .179	2.00	
	.250	1.50	2.00

## Knuckle (Size) Length

There are several knuckle sizes that are standard to most hinge manufacturers and sticking with the most popular one can make a huge difference in the hinge pricing. The overall length of the hinge may also be a deciding factor because hinges with all full knuckles tend to be cheaper. See more in the next section.

**GUDEN**

## Overall Length

Stock lengths of continuous hinges are available in either 72", 84" or sometimes 96" length depending on the size and their popularity. We can supply them cut to any length you want but if you can keep the length an equal multiple of the knuckle size you choose, it can often be less expensive. But choosing the more expensive option can help with retaining your pin due to a deformed knuckle end. See next section.

## Pin Retention

- Staked Pin - .075 thick and below
- Coined End - .060 thick and below
- Welded Pins - all thicknesses
- Crimped Ends - .090 thick and below
- Pin Spun Both Ends - all thicknesses
- None – Pin Retained by Friction - all thicknesses

Many longer lengthed hinges are often left without any pin retention at all because the pin is retained pretty much just from the long length of hinge, or the hinge is set into a space that doesn't allow the hinge pin to come out. But to prevent the hinge pin from "walking out" of the barrel, it's best to use some kind of pin retention. The more stakes you have, the less chance that the pin will be able to be taken out of the hinge. Keep in mind that in .035, .040, .050 and .060 thicknesses, hinges run standard with a stake every 3-4 inches which can be very cost effective. Coined pin ends retain the hinge pin, but can easily be hammered out if need be. In most cases, a partial knuckle is not desirable, but one advantage is that the deformed end often will sufficiently retain the pin without the need for an extra operation.

## With or Without Mounting Holes

- No holes for welding
- Standard holes or slots
- Standard countersunk holes
- Custom hole or slot sizes and patterns
- Custom threaded inserts

The majority of hinges without holes are mounted by welding, but for easier mounting, many hinges are supplied with either holes, slots or custom threaded inserts or studs. Various standard hole patterns are readily available and just about any hole pattern you would require can also be supplied. Keep in mind that some non-standard patterns may require a tooling charge.

## Custom Bends / Cuts / Swages

Don't forget that if you plan to modify the hinge, it might be cost effective to have the supplier do the custom operations for you. In addition to holes, slots and plating, hinges can be cut to length, bent, swaged, offset, and trimmed - nearly anything is possible. Simply provide us with a dimensional drawing to get a price quote.



## Common Finish Options

- Chemical Conversion
- Anodize
- Black Oxide
- Burnished
- Chrome
- Degrease
- Electro-Galvanize
- Electropolish
- Nickel
- Paint
- Powder-coat
- Polish
- Passivated
- Zinc
- NADCAP

One of the last decisions to make on your hinge is the finish. Often your continuous hinge will be finished along with the rest of your assembly, but if needed, Guden can supply the hinge with your specified finish. Most hinge lengths are in stock without a finish, and we also have a line of polished stainless continuous hinges suitable for the marine industry, medical and food industries or any application that needs a corrosion resistant hinge with a bright shiny finish. You can also choose from a selection of pre-plated brass and nickel continuous hinges that are also pre-punched with holes.

Considering a **Continuous hinge** for your application?

[Click here to see our standard Continuous hinges](#) 

(return to [top of this file](#))

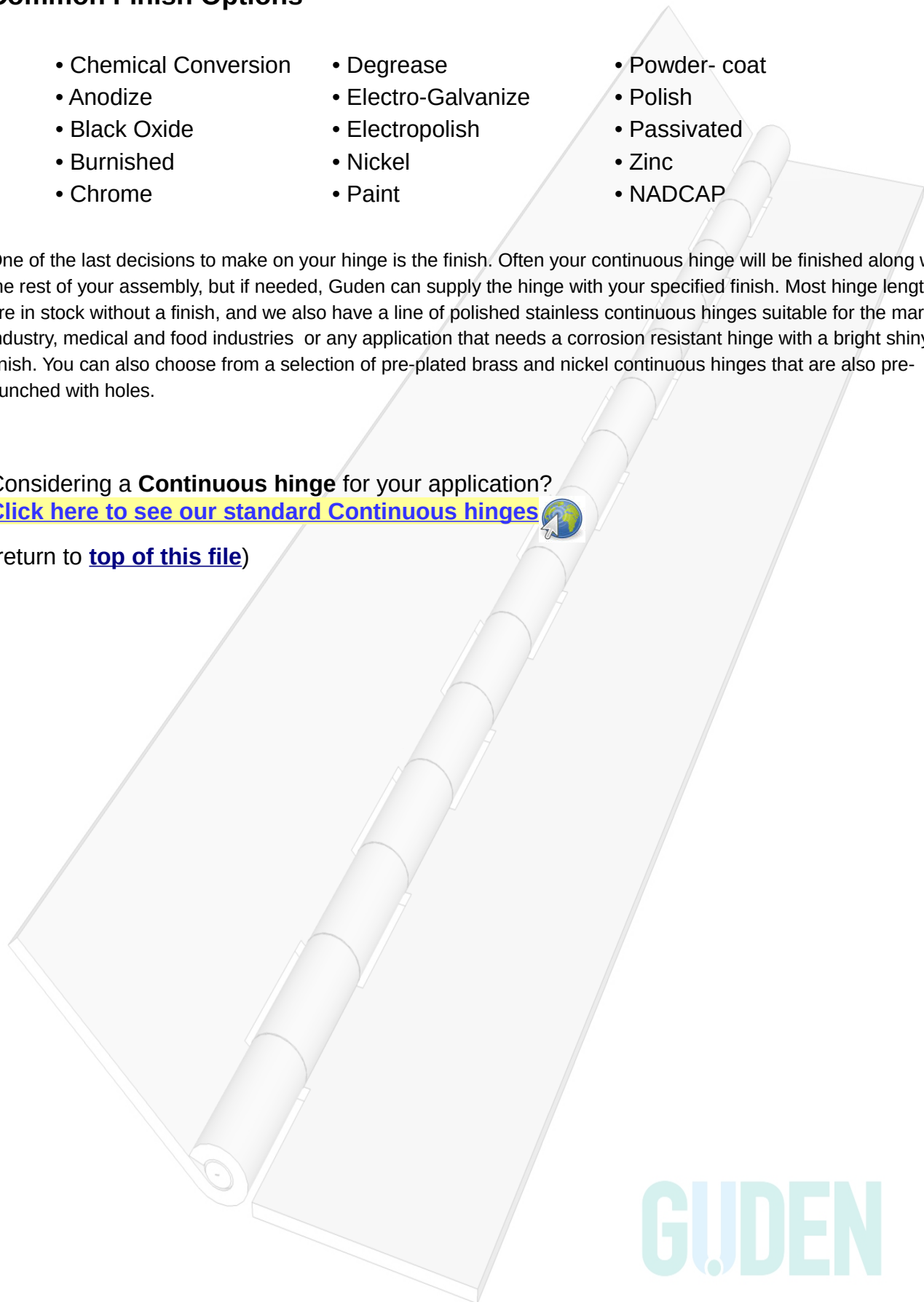

# GUDEN

## Butt Hinges

- Works well for both long and short door lengths
- Overall coverage and filling the door to chassis gap isn't required
- Preference is for smaller hinges spaced evenly for a more symmetrical look
- Fewer alignment issues for longer length doors due to accumulating tolerances for hole placement
- Mounting can be done by welding, or with perforations for fasteners
- Less hinge surface to have plated as compared to a continuous hinge length
- Less hinge material as compared to a continuous hinge length, translating to possible lower costs
- [Customization possibilities](#)  are extensive.



## Things to Consider When Choosing a Butt Hinge

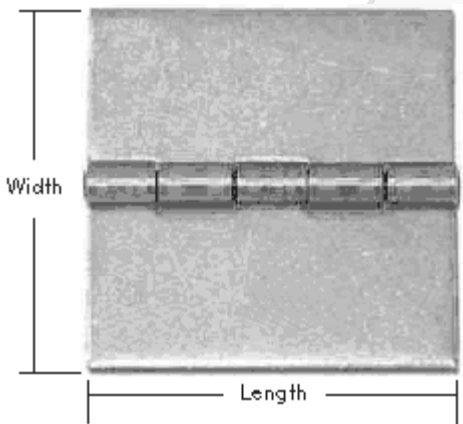

### Sampling and Testing

[Want free butt hinge engineering samples?](#) Sure! We know the value of prototyping and testing, and we strive to fill reasonable design sample requests quickly.

Building a prototype shouldn't have to be a major expense and an engineering analysis of a prototype is usually the best way to confirm that you have selected a safe and effective product for your application.

Working with the right supplier is the key to the success of your design process and you've already made a great choice with [Guden](#), the hardware experts. With almost 100 years of experience, the samples, information and advice you can get from us can be priceless in getting your prototype off the ground and onto the production floor.

**Video**  [Butt Hinges - Pin Retention - Pin spun both ends](#)

### Pin Size

There are usually only 1 or 2 choices of pin diameter for a given material thickness for butt hinges. As a general rule of thumb, the strongest butt hinge is one where the pin diameter is about twice the material thickness. The above listing are some of the most popular methods for pin retention, but you can also choose no retention at all for a loose pin, but you risk the pin just falling out of the hinge.

**GUDEN**



## Alignment

Butt hinges can provide a different look than continuous hinges but require careful pin alignment for smooth operation. Be sure to account for alignment in your plans.

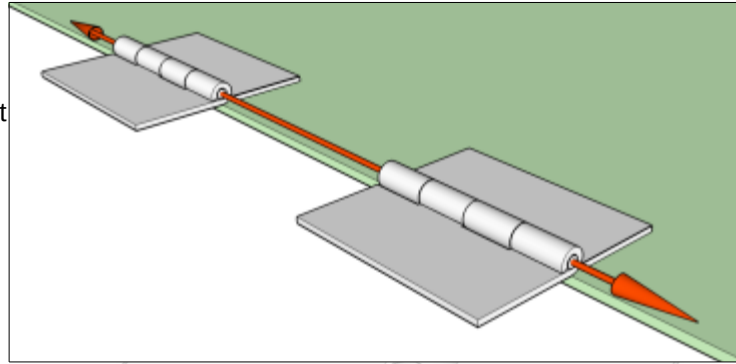

## Leaf Material and Thickness

Plain steel, type 302/304 stainless steel, type 316 stainless steel and type 5052 & 3003 aluminum are the most popular material choices for a butt hinge. It is also common to have the hinge material match the material of the cabinet or box.

For material thickness, a good starting point is to select the same thickness as the enclosure. If the enclosure has some unusual weight distribution, or a high or low door loads you may want to increase or possibly decrease the thickness.

## Pin Retention

- Staked Pin - the knuckle is lightly punched to grip the pin
- Coined Pin - the pin is flattened, then forced in, to grip tightly
- Pin Spun Both Ends - the pin is machined to make a cap on both ends
- Pin Welded in Place - the pin is welded in place to an end knuckle
- Knuckle Rolled Tight for Retention - the specially tight knuckle holds the pin

## Custom Bends / Cuts / Swages

Don't forget that if you plan to modify the hinge, it might be cost effective to have the supplier do the custom operations for you. In addition to holes, slots and plating, hinges can be cut to length, bent, swaged, offset, and trimmed - nearly anything is possible. Simply provide us with a dimensional drawing to get a price quote.

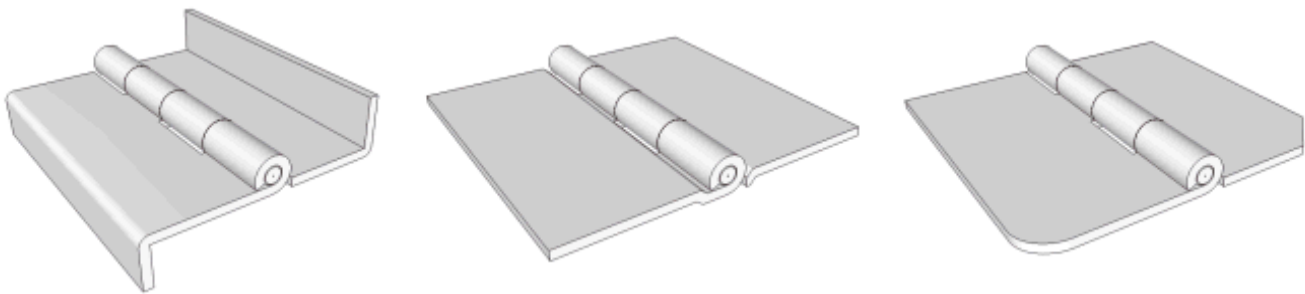

Considering a **Butt hinge** for your application?

[Click here to see our standard Butt hinges](#) 

(return to [top of this file](#))

# GUDEN

## Spring Hinges

- When a longer length is needed along a large door, but also works well in several shorter lengths on the door
- The hinge is supporting weight over a long length
- A lighter gauge hinge may hold more weight due to it's length
- For an overall coverage look or when you want the hinge to completely fill a gap
- More surface for door to hinge connection
- Mounting can be done by welding, or with perforations for fasteners
- [Customization possibilities](#)  are extensive.

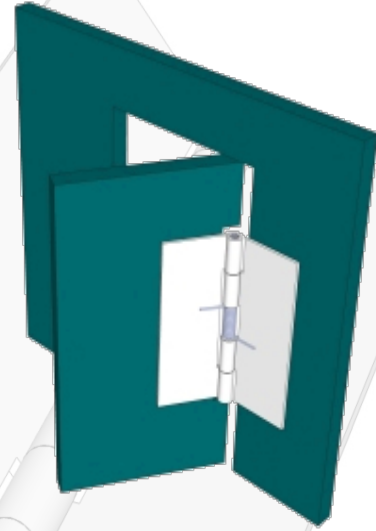

## Things to Consider When Choosing a Spring Hinge



### Sampling and Testing

[Want free spring hinge engineering samples?](#) Sure! We know the value of prototyping and testing, and we strive to fill reasonable design sample requests quickly.

Building a prototype shouldn't have to be a major expense and an engineering analysis of a prototype is usually the best way to confirm that you have selected a safe and effective product for your application.

Working with the right supplier is the key to the success of your design process and you've already made a great choice with [Guden](#), the hardware experts. With almost 100 years of experience, the samples, information and advice you can get from us can be priceless in getting your prototype off the ground and onto the production floor.

### Video

 [Guden Hinges Product Video - Spring Hinges](#)

# GUDEN

## Spring Load Direction

The first thing to decide about a spring hinge is which spring load direction your application requires. And with over 70 different stock spring hinges, you can choose from either spring-loaded-to-open and spring-loaded-to-close versions, and in sizes from .75" wide by 1.25" long up to 1.50" wide by 8.75" long.

Hinges that are spring-loaded open will push the leaves into the open position, or away from each other. Hinges that are spring-loaded to close will push the leaves into the closed position, or towards each other. Depending on what side of the panel or door you are mounting the spring hinge leaf, you always have to follow which way the spring leg is pushing the leaf to understand what kind of action you will get.

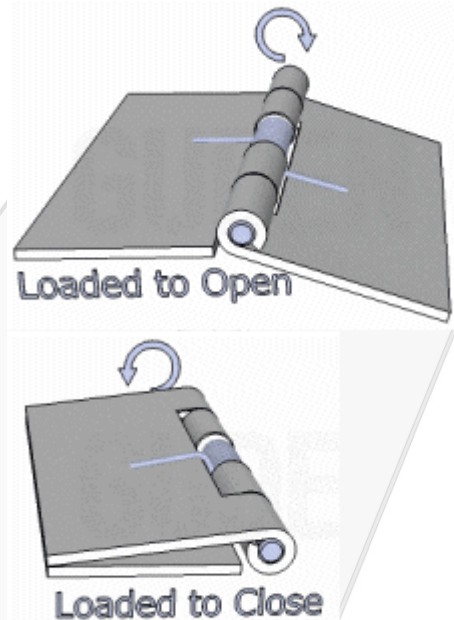

## Spring Force & Size

Choosing a standard spring hinge is often the most cost effective solution. We recommend first starting with a Guden stock spring hinge and then seeing how it works in your application. With this as a starting point, we can either add to that tension, or subtract from it. It may be as simple as looking at a stronger or weaker stock spring hinge or sometimes just adding another spring hinge to your door, or maybe just having one less. Often times we can supply a spring hinge with several torsion springs that you can begin removing to try to select the amount of spring force that you require. If a standard item just doesn't seem to do the trick, in many cases we can supply a spring hinge with a custom torsion spring created right to your specifications.

## Leaf Material and Thickness

- Cold Rolled Steel - Affordable
- Zinc Plated Steel - Affordable with Added Corrosion Resistance
- Stainless Steel - Corrosion Resistant
- Aluminum - Lightweight

The more popular choices for material in a spring hinge are plain steel, zinc plated steel, and type 302/304 stainless steel. You can also get them custom made in type 316 stainless steel, and also in aluminum. The pin is most often the same material as the leaf, and the springs can be steel spring wire, or stainless steel. It is also common to have the hinge material match the material of the cabinet or box.

For material thickness, a good starting point is to select the same thickness as the enclosure. If the enclosure has some unusual weight distribution, or a high or low door loads you may want to increase or possibly decrease the thickness.

## Custom Bends / Cuts / Swages

Don't forget that if you plan to modify the hinge, it might be cost effective to have the supplier do the custom operations for you. In addition to holes, slots and plating, hinges can be cut to length, bent, swaged, offset, and trimmed - nearly anything is possible. But again, depending on the spring leg locations. You may also be altering the spring force of the spring if you add an offset or swage to the spring hinge leaves as the spring leg may not lay flat. Simply provide us with a dimensional drawing to get a price quote.

**GUDEN**

## Pin Size and Retention

- Staked Pin - the knuckle is lightly punched to grip the pin
- Coined Pin - the pin is flattened, then forced in, to grip tightly
- No Pin Retention

There are usually only 1 or 2 choices of pin diameter for a given thickness of a spring hinge. As a general rule of thumb, the strongest spring hinge is one where the pin diameter is about twice the material thickness. The above listing are some of the most popular methods for pin retention on spring hinges, and in some cases, the tension of the spring coil tends to hold the pin in place so no retention is needed.

## With or Without Mounting Holes

- No Holes for Welding
- Standard Holes or Slots
- Standard Countersunk Holes
- Custom Holes or Slot Sizes and Patterns

The majority of spring hinges without holes are welded, but for easier mounting, many spring hinges are supplied with either holes, slots or custom threaded inserts or studs. Various standard hole patterns are readily available and just about any hole pattern you would require can also be supplied but dependent on where the spring leg lays on the leaf. Keep in mind that some non-standard patterns may require a tooling charge.

## Common Finish Options

- |                       |                     |               |
|-----------------------|---------------------|---------------|
| • Chemical Conversion | • Degrease          | • Powder-Coat |
| • Anodize             | • Electro-Galvanize | • Polish      |
| • Black Oxide         | • Electropolish     | • Passivated  |
| • Burnished           | • Nickel            | • Zinc        |
| • Chrome              | • Paint             | • NADCAP      |

One of the last decisions to make on your hinge is the finish. Often your spring hinge will be finished along with the rest of your assembly, but if needed, Guden can supply the hinge with your specified finish. Most spring hinges are in stock without a finish.

Considering a **Spring hinge** for your application?

[Click here to see our standard Spring hinges](#) 

(return to [top of this file](#))

## Plastic Continuous Hinges



- When a longer length is needed along a large door, but also works well in several shorter lengths on the door
- The hinge is supporting weight over a long length
- For an overall coverage look or when you want the hinge to completely fill a gap
- More surface for door to hinge connection
- Mounting can be done with perforations for fasteners
- Customization possibilities are limited
- Standard widths, colors and lengths offered
- May be cut to any length

## Things to Consider When Choosing a Continuous Plastic PolyHinge

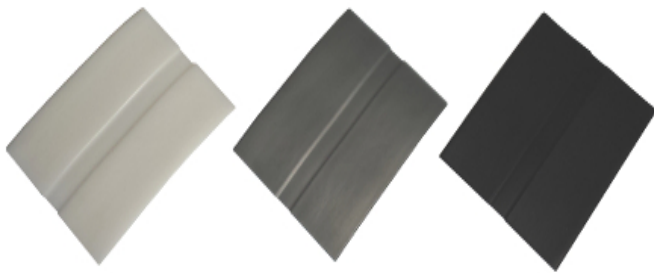

### Sampling and Testing

[Want free plastic continuous polyhinge engineering samples?](#) Sure! We know the value of prototyping and testing, and we strive to fill reasonable design sample requests quickly.

Building a prototype shouldn't have to be a major expense and an engineering analysis of a prototype is usually the best way to confirm that you have selected a

safe and effective product for your application.

Working with the right supplier is the key to the success of your design process and you've already made a great choice with [Guden](#), the hardware experts. With almost 100 years of experience, the samples, information and advice you can get from us can be priceless in getting your prototype off the ground and onto the production floor.

### Non-Metal Applications

Continuous plastic hinges are great for use when a non-metal solution is important for your application. They are non-conductive, weatherproof and with a one piece construction, can be watertight.

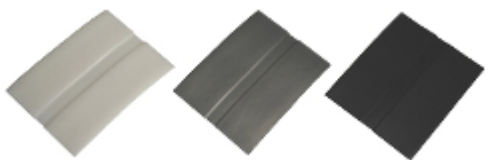
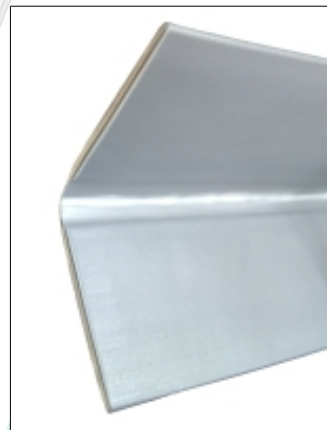

### Plastic Poly Hinge Properties

Our poly hinges are a unique one piece construction with a thinner

center section that allows the hinge to move. Flexing the hinge actually strengthens the thermoplastic molecules and their bond together increases. They are lightweight, and resistant to acids, oils and grease.



## Polyolefin Material Specifications and Colors

Poly hinges are made from a high quality polyolefin material and are available in one thickness, with a choice of 4 standard widths. Choose the best width for your application to completely cover the gap, or just hinge two pieces together. To match numerous applications, they are available in three color choices: black, gray or white.

## Mounting Methods

Metal hinges often are restricted to flat surfaces, and have specific mounting requirements. A poly hinge works well on slightly uneven surfaces and are best mounted with holes and fasteners. Adhesives may also be used, but with an infinite number of materials that the poly hinge can be mounted to, a company who specializes in adhesives would give the best advice for which type to use.

## Almost Unlimited Lengths

Our standard stock length is 72". You can also buy it in the 100 foot roll, and we can cut to any length you desire. This helps expand the applications you can use a hinge of this type for, even using it on a 100 foot door is possible.

Considering a **Plastic Continuous hinge** for your application?

[Click here to see our standard Plastic Continuous hinges](#) 

(return to [top of this file](#))



**GUDEN**



## Concealed and Invisible Hinges

- When closed, hinge cannot be seen or tampered with
- Concealed hinges have a longer curved leaf to allow for a minimum gap between the door and chassis
- Invisible hinges are mounted completely within the door thickness and embedded into the chassis as well
- Mounting can be done with perforations for fasteners
- Customization possibilities are limited

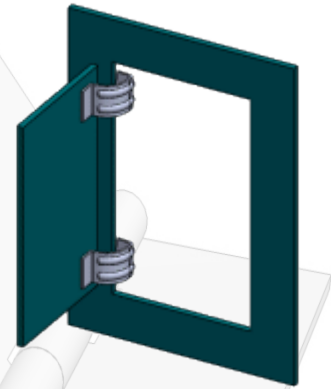

## Things to Consider When Choosing a Concealed or Invisible Hinge

### Sampling and Testing

[Want free concealed and invisible hinge engineering samples?](#)

Sure! We know the value of prototyping and testing, and we strive to fill reasonable design sample requests quickly.

Building a prototype shouldn't have to be a major expense and an engineering analysis of a prototype is usually the best way to confirm that you have selected a safe and effective product for your application.

Working with the right supplier is the key to the success of your design process and you've already made a great choice with [Guden](#), the hardware experts. With almost 100 years of experience, the samples, information and advice you can get from us can be priceless in getting your prototype off the ground and onto the production floor.

### Cosmetic Appeal

Concealed hinges are most often used in applications that require the hinge to be hidden from view. Even seeing the barrel of the hinge between the door and the chassis isn't wanted, so the only choice would be to have the hinge completely on the inside surfaces, or within the door and chassis frame itself.



# GUDEN

## Hinge Product Choices

Guden carries two types of hidden hinges:

- **Concealed hinges** have a longer curved leaf to allow for a minimum gap between the door and chassis, and to let it swing up and over the chassis edge for a wide open arc. They are mounted on the underside, or backside of the door, so they are completely hidden from view until the door is opened.
- **Invisible hinges** are mounted completely within the door thickness and embedded into the chassis as well. They are constructed of numerous meshed metal arms that allow for the hinge to fold in on itself, and then extend out to swing the door up and over the chassis frame. This forms a much more solid connection, with less hinge play than a concealed hinge.

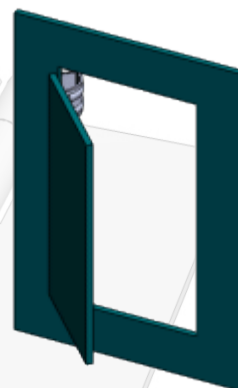

## Custom Operations

[Concealed hinges](#) are available in stock with and without holes, and in steel, zinc plated steel and stainless steel. Custom holes or slots are also an option.

[Invisible hinges](#) are in stock in select sizes, with many other sizes readily available upon request. Consult with a Guden Customer Service Representative for your requirement. There are also specific constructions of invisible hinges that are designed to fit either metal or wood cabinetry.

Considering a **Concealed or Invisible hinge** for your application?

[Click here to see our standard Concealed hinges](#) 

[Click here to see our standard Invisible hinges](#) 

(return to [top of this file](#))

The logo for GUDEN, featuring the word "GUDEN" in a bold, light blue, sans-serif font. The letter "U" is stylized with a vertical line through its center.

## Slip Joint Hinges

- Two piece male and female set allows for easy removal and reassembly of the door
- Hinge relies on weight and gravity to keep the male and female connected in vertical applications, but requires an outside stop on the door to prevent the disassemble process in horizontal applications
- Hinge separation requires female half to be lifted off, or slid off the pin half
- Right hand and left hand versions allow for mounting on mirror image doors
- Works better for shorter length doors due to alignment
- Mounting can be done by welding, or with perforations for fasteners
- [Customization possibilities](#)  are extensive

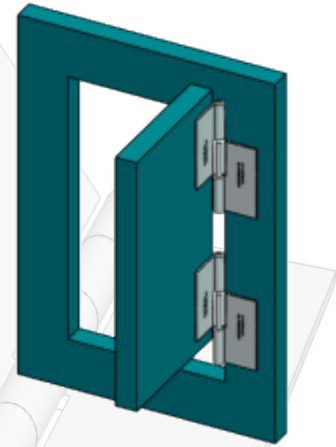

## Things to Consider When Choosing a Slip Joint Hinge

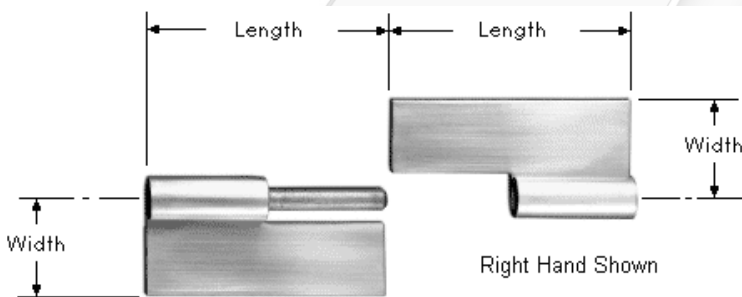

## Sampling and Testing

[Want free slip joint hinge engineering samples?](#) Sure! We know the value of prototyping and testing, and we strive to fill reasonable design sample requests quickly.

Building a prototype shouldn't have to be a major expense and an engineering analysis of a prototype is usually the best way to confirm that you have selected a safe and effective product for

your application.

Working with the right supplier is the key to the success of your design process and you've already made a great choice with [Guden](#), the hardware experts. With almost 100 years of experience, the samples, information and advice you can get from us can be priceless in getting your prototype off the ground and onto the production floor.

## Videos

 [Guden Hinge Terminology - Slip Hinges](#)

 [Guden Slips - The Sequel](#)

The logo for GUDEN, featuring the word 'GUDEN' in a large, bold, light blue sans-serif font.

## Alignment

Slip hinges allow for easy removal of a door or cover but require careful pin alignment for smooth operation. Be sure to account for alignment in your mounting. For larger doors, you may also want to consider a [continuous slip hinge](#) .

## Space For Removal

Slip joints operate by sliding the female hinge off the pin on the male hinge. You need to take note of the length of the pin, and make sure you have at least that distance of space in the up direction (on vertical doors) or to the side (on horizontal doors) to remove the door.

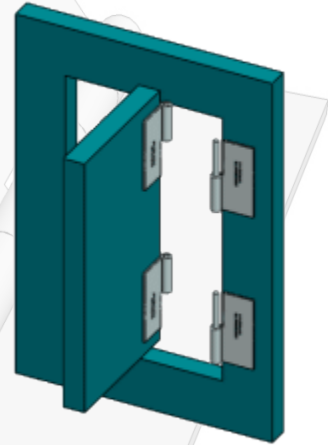

## Right or Left Hand Version

Slip joint hinges are supplied in a right hand version and a mirror image left hand version. Depending on the side that you're mounting the slip hinge on, and where you're mounting it will determine which version you want. Typically, if the hinge is mounted on the outside of the chassis and door, then right hand versions are used for the right hand side of your door, and vice versa. Check our helpful video on

[YouTube](#) [how to tell a right hand slip hinge from a left hand.](#)

## Leaf Material and Thickness

- Cold Rolled Steel - Affordable
- Stainless Steel - Corrosion Resistant
- Aluminum - Lightweight

Plain steel and type 302/304 stainless steel are the most popular material choices for a slip joint hinge. With type 316 stainless steel and aluminum also available as well. It is also common to have the hinge material match the material of the cabinet or box.

For material thickness, a good starting point is to select the same thickness as the enclosure. If the enclosure has some unusual weight distribution, or a high or low door loads you may want to increase or possibly decrease the thickness.

## Pin Retention

- Staked Pin - the knuckle is lightly punched to grip the pin
- Knuckle Curled Tight for Retention - the specially tight knuckle holds the pin
- Knurled or Splined Pin - grooves in the pin grip to walls of knuckle
- Pin Welded in Place - the pin is welded in place to the end knuckle

## Pin Size

# GUDEN

As a basic rule, there are usually 1 or 2 options for a pin diameter with a given thickness of a slip joint hinge. Most often, the strongest slip joint hinge is one where the pin diameter is about twice the material thickness. For a slip hinge, the pin being stationary is most important so it's retention is key. You may have a choice for how the pin is retained, but in all situations, for the hinge to work, it must be fixed in place on the male hinge half.

## With or Without Mounting Holes

- No Holes for Welding
- Standard Holes or Slots
- Standard Countersunk Holes
- Custom Holes or Slot Sizes or Patterns
- Custom Threaded Inserts

Many hinges without holes are mounted by welding, but for easier mounting, many hinges can also be supplied with holes, slots or custom threaded inserts or studs. Various standard hole patterns are readily available and just about any hole pattern you need can also be supplied. Keep in mind that some non-standard patterns may require a tooling charge.

## Custom Bends / Cuts / Swages

If you are modifying the hinge, it may also be good to compare how cost effective it is to have the supplier do the operations for you. In addition to holes, slots and plating, slip joint hinges can also be cut to width, bent, swaged, offset - nearly anything is possible. Larger sizes, thicknesses and lengths can also be supplied. Simply provide us with a dimensional drawing to get a price quote.

## Common Finish Options

- |                       |                     |                |
|-----------------------|---------------------|----------------|
| • Chemical Conversion | • Degrease          | • Powder- Coat |
| • Anodize             | • Electro-Galvanize | • Polish       |
| • Black Oxide         | • Electropolish     | • Passivated   |
| • Burnished           | • Nickel            | • Zinc         |
| • Chrome              | • Paint             | • NADCAP       |

Many stock slip hinges are plain finish metal, but there are also plated versions available as well. Often your slip joint hinge will be finished along with the rest of your assembly, but if needed, Guden can supply the hinge with your specified finish. We also have a line of electro-polished stainless slip joint hinge that has holes and rounded corners. It's suitable for the marine industry or any application that needs a corrosion resistant hinge with a bright shiny finish.

Considering a **Slip Joint hinge** for your application?

[Click here to see our standard Slip Joint hinges](#) 

(return to [top of this file](#))

# GUDEN

## Weld-On Hinges

- Two piece male and female set allows for easy removal and reassembly of the door
- Hinge relies on weight and gravity to keep the male and female connected in vertical applications, but requires an outside stop on the door to prevent the disassemble process in horizontal applications
- Hinge separation requires female half to be lifted off, or slid off the pin half
- Leafless design allows for mounting on either side of the door
- Works better for shorter length doors due to alignment
- Leafless design offers a cleaner, more streamlined look
- Leafless design of Weld-On hinges allows for mounting by welding only
- Customization possibilities are limited
- Custom sizes are available depending on order quantity
- Ability to change pin material. Body and pins do not have to be the same material
- Add a grease fitting for lubrication capability

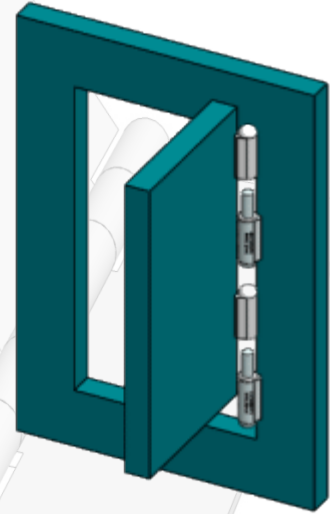

## Things to Consider When Choosing a Weld-On Hinge



### Sampling and Testing

[Want free weld on hinge engineering samples?](#) Sure! We know the value of prototyping and testing, and we strive to fill reasonable design sample requests quickly.

Building a prototype shouldn't have to be a major expense and an engineering analysis of a prototype is usually the best way to confirm that you have selected a safe and effective product for your application.

Working with the right supplier is the key to the success of your design process and you've already made a great choice with [Guden](#), the hardware experts. With almost 100 years of experience, the samples, information and advice you can get from us can be priceless in getting your prototype off the ground and onto the production floor.

# GUDEN



## Alignment

Weld-on hinges allow a door or cover to be easily removed but require careful pin alignment for smooth operation. Be sure to account for alignment in your mounting.

## Space For Removal

Weld-on hinges operate by sliding the female hinge off the pin on the male hinge. You need to take note of the length of the pin, and make sure you have at least that distance of space in the up direction (on vertical doors) or to the side (on horizontal doors) to remove the door.

## Weld-On Hinge Attributes

These hinges are unique because unlike other hinge types, these are leafless. They're a solid metal tube with a small special edge on the cylinder to allow for welding. Because of this design, they're most often considered for use because of the cleaner more streamlined look they give to an application. They're also great for applications where there may not be room for a hinge leaf.

## Materials

- Plain Steel Body and Pin
- Plain Steel Body with a Brass Pin
- Plain Steel Body with a Stainless Steel Pin
- Stainless Steel Body and Pin
- Type 316 Stainless Steel Body and Pin
- Aluminum Body with a Stainless Steel Pin

There are many material combinations for weld-on hinges. Custom combinations can also be supplied, but are dependent on the production quantity.

## Grease Fitting Attachment

For ease in adding lubrication, there are several sizes available from stock with a grease fitting attachment already installed on the female hinge half. Additional sizes can also have this attachment added as a custom run.

Considering a **Weld-On hinge** for your application?

[Click here to see our standard Weld-On hinges](#) 

(return to [top of this file](#))

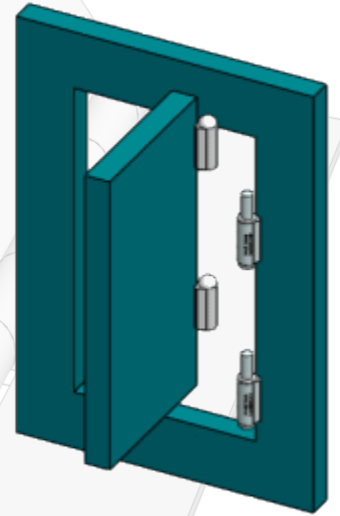

# GUDEN

## Un-Hinges

- Two piece male and female set allows for easy removal and reassembly of the door
- Pin is locked in the extended position and requires a rotation and retraction to pull the pin back to disassemble the hinge set
- This hinge set can be used in both vertical and horizontal applications and always requires a manual operation to separate the two hinge pieces
- Due to retracting hinge pins, hinge separation is only a matter of pulling door away from chassis. No lifting up or pulling to the side is necessary
- Mounting can be done by welding, or with perforations for fasteners

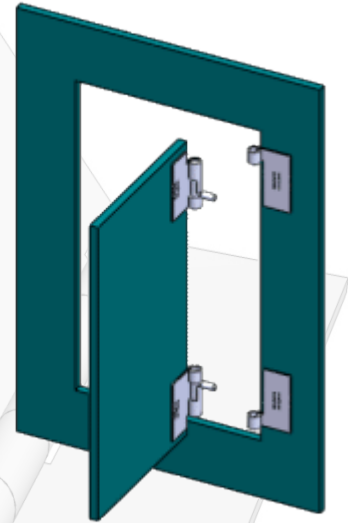

## Things to Consider When Choosing an Un-Hinge



### Sampling and Testing

[Want free Un-Hinge engineering samples?](#) Sure! We know the value of prototyping and testing, and we strive to fill reasonable design sample requests quickly.

Building a prototype shouldn't have to be a major expense and an engineering analysis of a prototype is

usually the best way to confirm that you have selected a safe and effective product for your application.

Working with the right supplier is the key to the success of your design process and you've already made a great choice with [Guden](#), the hardware experts. With almost 100 years of experience, the samples, information and advice you can get from us can be priceless in getting your prototype off the ground and onto the production floor.

### Alignment

Unique Guden Un-Hinges allow for easy removal of a door or cover but for a smoother operation, it's important that they are in line with each other. Be sure to account for alignment in your mounting. For larger doors, you may also want to consider a [continuous slip hinge](#) .

### Retract and Hold Pin Feature

The Un-Hinge is expertly crafted with retractable pins that operate through a spring loaded pin stem. With slight pressure, the pin stem can be pulled back to retract the pin, then rotated to a locked position to leave the pin retracted. The door can then quickly be removed.

**GUDEN**

## One and Two Pin Versions

Our larger Un-Hinge has two retracting pins, one on each end of the leaf that extend and fit into mating female leaf. We also carry one pin versions that can be used for latching a door, or a quick release door. One version has a pin that extends beyond the leaf edge for latch style applications where the pin fits into a hole in the chassis or frame. The second version has a pin that extends just to the edge of the leaf edge so when mated with it's female half, the hinge is completely square.

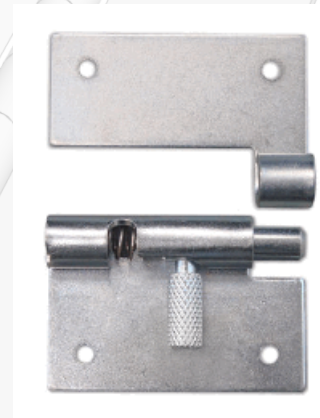
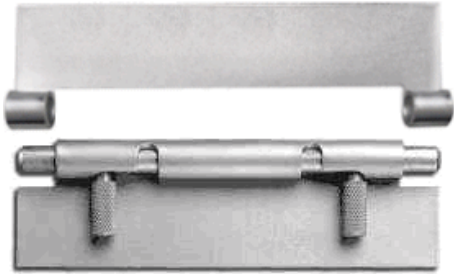

## Customization Possibilities

- Holes, slots, other perforations
- Notches and cutouts
- Radius and clipped corners
- Hardware inserts, studs and standoffs

## Space For Removal

Un-Hinges operate by retracting the pins, then pulling the female leaf away from the male leaf. No sliding or lifting is required, so they work well in tighter spaces.

Considering an **Un-hinge** for your application?

[Click here to see our standard Un-hinges](#) 

(return to [top of this file](#))

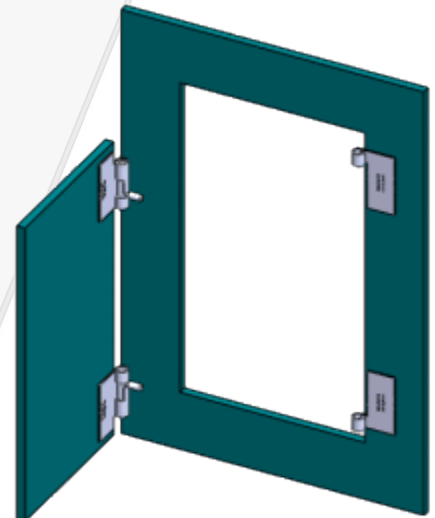

# GUDEN

## Latch Hinges

- Single piece allows for easy removal and reassembly of the door
- Hinge relies on weight and gravity to keep the male and female connected in vertical applications, but requires an outside stop on the door to prevent the disassemble process in horizontal applications
- Works better for shorter length doors due to alignment
- Mounting can be done by welding, or with perforations for fasteners
- Customization possibilities are extensive
- Custom sizes are available depending on order quantity

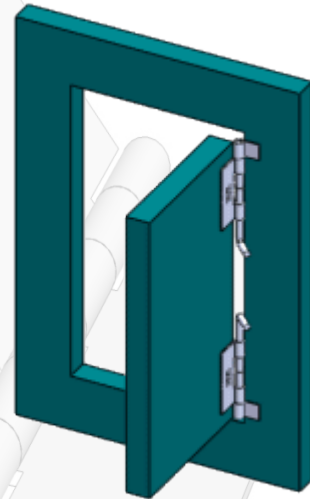

## Things to Consider When Choosing a Spring Latch Hinge

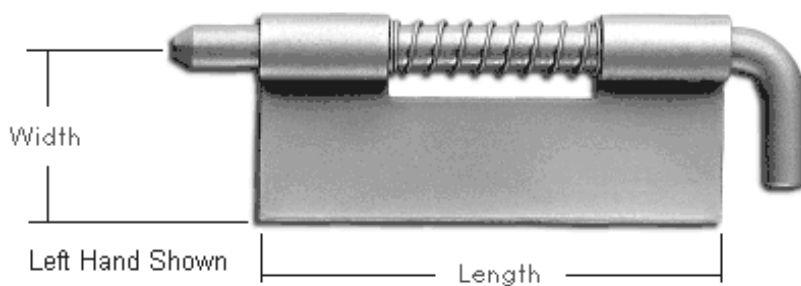

### Sampling and Testing

[Want free spring latch hinge engineering samples?](#) Sure! We know the value of prototyping and testing, and we strive to fill reasonable design sample requests quickly.

Building a prototype shouldn't have to be a major expense and an engineering

analysis of a prototype is usually the best way to confirm that you have selected a safe and effective product for your application.

Working with the right supplier is the key to the success of your design process and you've already made a great choice with [Guden](#), the hardware experts. With almost 100 years of experience, the samples, information and advice you can get from us can be priceless in getting your prototype off the ground and onto the production floor.

## Alignment

Spring latch hinges are a unique one leaf construction with a spring loaded retractable pin. The pin is bent on one end, and the bend is used to pull the pin back for removal or release of the door or lid. The pin needs to be carefully and accurately in alignment with its receptacle or the hole in the door to engage the door in place.

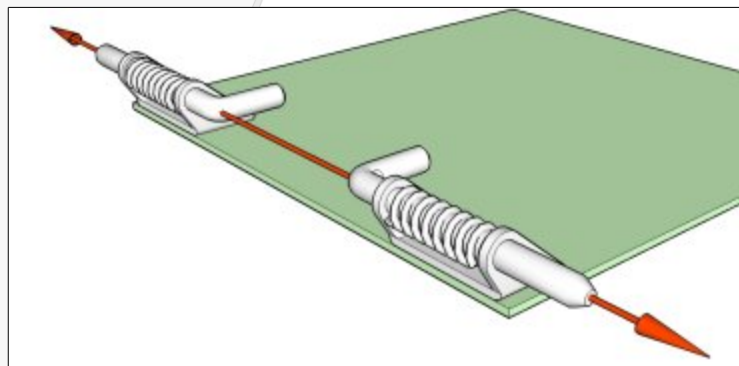

## Space For Removal

By pulling back on the bent portion of the spring latch hinge pin, the pin retracts and the door or cover is able to be swung down, away, or completely removed without the need for any extra space. This product can also be used on both horizontal and vertical applications. We do not supply a mating female leaf as the typical use has the pin engaging with a hole in the sheet metal chassis or frame.

## Typical Uses

When using it to hinge a door, you typically will use a right hand and a left hand version, pointing in opposite directions to ensure the door is hinged to the frame. For latching applications, you typically can use a single unit on one side to hold the door up or vertical before lowering it or swinging it open. The door or cover will already have another hinge on it that serves as the pivot point.

## Right or Left Hand Version

Spring latch hinges are supplied in a right hand version and a mirror image left hand version. The easiest way to tell a right hand from a left hand is to lay the hinge on a flat surface with the leaf flat on the table and the barrel is on the topside of the leaf. Then make sure that the pin is on the edge of the leaf farthest away from you, not on the edge of the leaf closest to you. If the pin is pointing to the left, it's a left hand version, and vice versa.

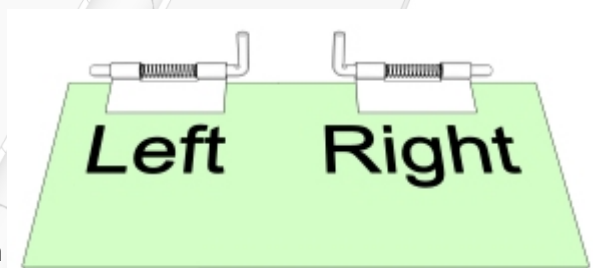

## Leaf Material and Thickness

- Cold Rolled Steel – Affordable
- Zinc Plated Steel – Affordable and Corrosion Resistant
- Type 302/304 Stainless Steel – Corrosion Resistant

Steel, zinc plated steel and stainless steel are the popular material choices for spring latch hinges.

## With or Without Mounting Holes

- No Holes for Welding
- Standard Holes or Slots
- Custom Holes or Slot Sizes or Patterns
- Custom Threaded Inserts

Spring latch hinges are available in stock both with and without holes for mounting. Custom holes and slots are also available as a custom request.

**GUDEN**

## Custom Bends / Cuts / Swages

If you are modifying the hinge, it may also be good to compare how cost effective it is to have the supplier do the operations for you. In addition to holes, slots and plating, spring latch hinges can also be cut to width, bent, swaged, offset - nearly anything is possible. Larger sizes, thicknesses, lengths, and pin styles can also be supplied. Simply provide us with a dimensional drawing to get a price quote.

## Common Finish Options

- Chemical Conversion
- Anodize
- Black Oxide
- Burnished
- Chrome
- Degrease
- Electro-Galvanize
- Electropolish
- Nickel
- Paint
- Powder-coat
- Polish
- Passivated
- Zinc
- NADCAP

The majority of stock spring latch hinges are zinc plated steel or stainless steel, but there are also plain steel versions available. Other finishes are also available to suit your application requirements.

Considering a **latch hinge** for your application?

[Click here to see our standard latch hinges](#) 

(return to [top of this file](#))



**GUDEN**



## Butt Hinges with Removable Pins

- Pins lift, then door moves
- Works better for shorter length doors due to alignment
- Mounting can be done by welding, or with perforations for fasteners
- Customization possibilities are extensive
- Custom sizes are available depending on order quantity

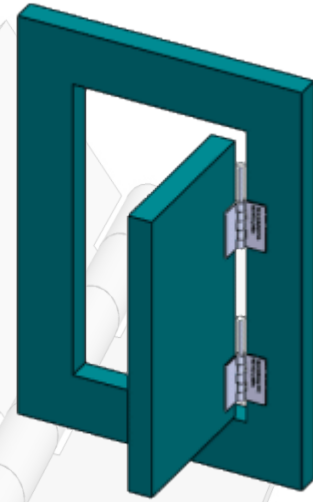

## Things to Consider When Choosing a Butt Hinge with Removable Pins

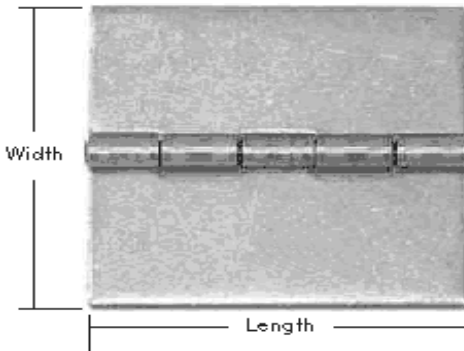

### Sampling and Testing

[Want free butt hinge with removable pins engineering samples?](#) Sure! We know the value of prototyping and testing, and we strive to fill reasonable design sample requests quickly.

Building a prototype shouldn't have to be a major expense and an engineering analysis of a prototype is usually the best way to confirm that you have selected a safe and effective product for your application.

Working with the right supplier is the key to the success of your design process and you've already made a great choice with [Guden](#), the hardware

experts. With almost 100 years of experience, the samples, information and advice you can get from us can be priceless in getting your prototype off the ground and onto the production floor.

### Alignment

Butt hinges can provide a different look than continuous hinges but require careful pin alignment for smooth operation. Be sure to account for alignment in your plans.

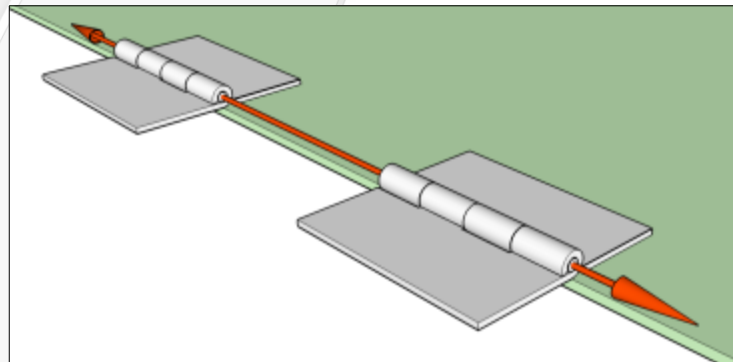

GUDEN

## Leaf Material and Thickness

Plain steel, type 302/304 stainless steel, type 316 stainless steel and type 5052 & 3003 aluminum are the most popular material choices for a butt hinge. It is also common to have the hinge material match the material of the cabinet or box.

For material thickness, a good starting point is to select the same thickness as the enclosure. If the enclosure has some unusual weight distribution, or a high or low door loads you may want to increase or possibly decrease the thickness.

## Pin Retention

- Staked Pin - the knuckle is lightly punched to grip the pin
- Coined Pin - the pin is flattened, then forced in
- Pin Spun One End - the pin is machined to make a cap on one end
- Knuckle Rolled Tight for Retention - the specially tight knuckle holds the pin

## Pin Size

There are usually only 1 or 2 choices of pin diameter for a given material thickness of a butt hinge. As a general rule of thumb, the strongest hinge is one where the pin diameter is about twice the material thickness. The above listing are some of the most popular methods for pin retention, but you can also choose no retention at all for a loose pin, but you risk the pin just falling out of the hinge.

## With or Without Mounting Holes

- No Holes for Welding
- Standard Holes or Slots
- Standard Countersunk Holes
- Custom Holes or Slot Sizes or Patterns
- Custom Threaded Inserts

The majority of hinges without holes are mounted by welding, but for easier mounting, many hinges are supplied with either holes, slots or custom threaded inserts or studs. Various standard hole patterns are readily available and just about any hole pattern you would require can also be supplied. Keep in mind that some non-standard patterns may require a tooling charge.

## Custom Bends / Cuts / Swages

Don't forget that if you plan to modify the hinge, it might be cost effective to have the supplier do the custom operations for you. In addition to holes, slots and plating, hinges can be cut to length, bent, swaged, offset, and trimmed - nearly anything is possible. Simply provide us with a dimensional drawing to get a price quote.

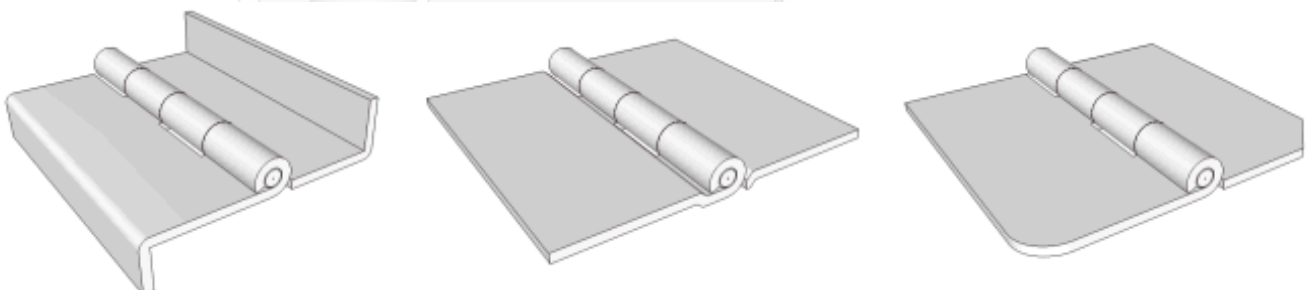

## Common Finish Options

- Chemical Conversion
- Anodize
- Black Oxide
- Burnished
- Chrome
- Degrease
- Electro-Galvanize
- Electropolish
- Nickel
- Paint
- Powder-coat
- Polish
- Passivated
- Zinc
- NADCAP

One of the last decisions to make on your hinge is the finish. Often your butt hinge will be finished along with the rest of your assembly, but if needed, Guden can supply the hinge with your specified finish. Most butt hinges are in stock without a finish, and we also have a line of electro-polished stainless butt hinges suitable for the marine industry or any application that needs a corrosion resistant hinge with a bright shiny finish.

Considering a **butt hinge with removable pin** for your application?

[Click here to see our standard butt hinges with removable pins](#) 

(return to [top of this file](#))

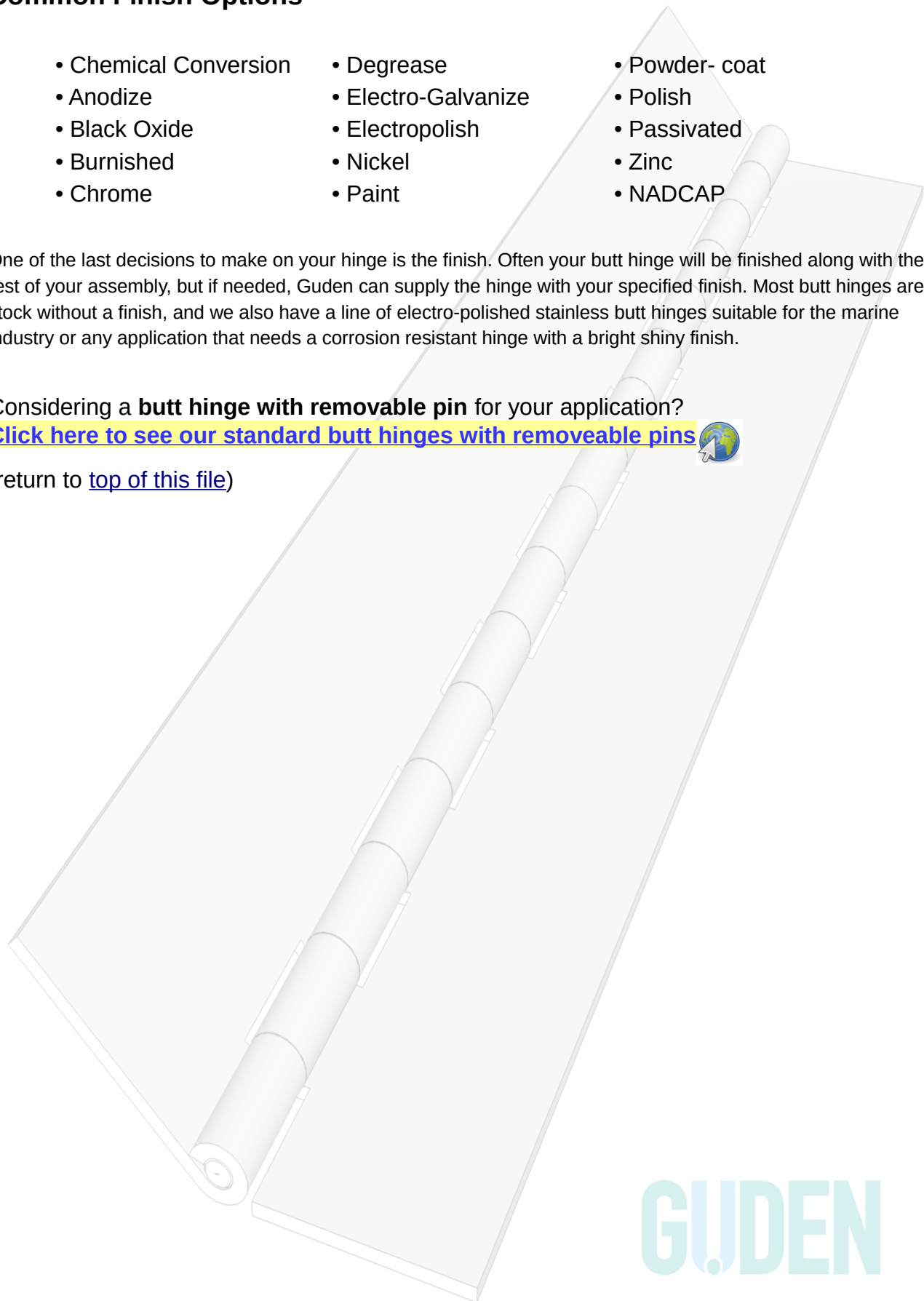

# GUDEN

**End Note:**

We hope this has been helpful to you and would [welcome any feedback](#) you have that will improve this guide.

**H. A. Guden Co., Inc.**

**Follow us on:**



(return to [top of this file](#))

**H. A. Guden Co., Inc.**  
99 Raynor Avenue  
Ronkonkoma NY 11779 USA  
1-631-737-2900  
1-800-344-6437 (US)

**GUDEN**  
<http://www.Guden.com>